	QMS Work Instruction MTS Systems Corporation – MTS Test	Document Number: EHS-300-187	Rev.: A
Title: Non-Powered, Material Movement Work Instruction		Page #: 1 of 20	
Work Instruction Owner(s) – list functions: All MTS-EP- Operations Departments and Functional Groups (System Assembly, Checkout, Material Management, Actuator Assembly/Testing, Facilities, etc)		Revision's Training Requirements – select one (per section #9): Awareness _ Formal X	

TABLE OF CONTENTS

Section	Page
1 Table of Contents	1
2 Purpose	2
3 Scope	2
4 Definitions	2-4
5 Graphic	5-7
6 Responsibilities by Function	7-9
7 Work Instructions	9-17
8 Associated Quality Records	18
9 Forms / Templates	18
10 Revision Training Requirements	19
11 Revision History & Approval	20

	QMS Work Instruction MTS Systems Corporation – MTS Test	Document Number: EHS-300-187	Rev.: A
Title: Non-Powered, Material Movement Work Instruction		Page #: 2 of 20	
Work Instruction Owner(s) – list functions: All MTS-EP- Operations Departments and Functional Groups (System Assembly, Checkout, Material Management, Actuator Assembly/Testing, Facilities, etc)		Revision's Training Requirements – select one (per section #9): Awareness _ Formal X	

1 PURPOSE

- 1.1** This work instruction is to ensure that all personnel involved with the non-powered manipulation of materials: seizing, holding, grasping, turning, or otherwise working with the hands to move individual items by lifting, lowering, filling, emptying, or carrying, in addition to the human powered use of mobile, non-powered pallet jacks, carts, racking etc.. are properly informed of all the hazards associated with these manual tasks and trained regarding safe manual movement practices

2 SCOPE

- 2.1** This work instruction applies to all MTS Operations group and functional area employees, who work at the MTS – Eden Prairie facility.

3 DEFINITIONS AND ACRONYMS

Aisle: The space between storage aids used by material handling equipment and or personnel for movement of items

Administrative Improvements: include such items as - alternating heavy tasks with light tasks, providing job variety or rotation to reduce or eliminate repetition (over use of the same muscle group), adjusting work schedules, work pace and practices, provide recovery time (short rest breaks), modify work so that workers perform within the bodies' power zone = above the knees and the below the shoulders, closer to the waist or chest)

Awkward Postures: movement that pertains to whole body or body part bending and twisting

Bulk Container: bulk containers are heavy duty containers designed for bulk storage material handling

Bulk Packing: the process or act of placing numbers of small cartons or boxes into a larger single box to aid in the movement of product/materials and to prevent damage to smaller containers

Bulk Storage: the process of storing materials and packages in larger quantities, generally using the original packaging or shipping containers/boxes

Capacity Rating: a maximum recommended uniformly distributed static load capacity

	QMS Work Instruction MTS Systems Corporation – MTS Test	Document Number: EHS-300-187	Rev.: A
Title: Non-Powered, Material Movement Work Instruction		Page #: 3 of 20	
Work Instruction Owner(s) – list functions: All MTS-EP- Operations Departments and Functional Groups (System Assembly, Checkout, Material Management, Actuator Assembly/Testing, Facilities, etc)		Revision's Training Requirements – select one (per section #9): Awareness _ Formal X	

Carts: Wheeled devices, generally made from plastic and or metal, utilized to move items within a warehouse distribution center or manufacturing facility. They can be equipped with drawers, bins or flat surfaces to secure items for transport and storage and can utilize casters as well as pneumatic and semi-pneumatic wheels

Chain Hoist: Generally any hoist which utilized link, or roller chain as its lifting medium. Chain hoists can be manually operated (hand/lever) or pneumatically/electrically driven

Chocks: triangular blocks of rubber, wood, or metal placed in front of, between or behind items and objects (or wheels) to prevent accidental material movement

Crane: a machine for lifting and lowering a load and moving it horizontally. Drives may be manual, power or a combination and rated for a wide variety of loads

Forklift / Fork truck: a vehicle with a pronged device in front for lifting and carrying heavy loads

Forceful Exertions: the movement or carrying of heavy load

Hand Truck: A two wheeled cart for moving objects by hand, consisting of a vertical framework with handles on the top and a metal plate/blade at the bottom that is inserted beneath a load, the entire assembly is tilted backward until balanced for easy pushing/pulling

Load Capacity: the maximum total weight that can be handled by material handling equipment without sacrifice of any of the applicable published specifications of the equipment

Load Height: maximum overall dimension from the bottom of a pallet or load to the top

Load Length: maximum overall dimension of a pallet or load module, measured in the direction perpendicular to the length of the side for conventional fork truck or pallet jack handling

Pallet Jack: A manually operated device for lifting and moving pallets. The jack is steered by a 'tiller' like lever that also acts as the pump handle for raising the jack. A small handle on the tiller releases the hydraulic fluid, causing the forks to lower. As the hydraulic jack at the 'tiller' end is raised, the links force the wheels down, raising the forks vertically above the front wheels, raising the load upward until it clears the floor. The pallet is only lifted enough to clear the floor for subsequent travel.

	QMS Work Instruction MTS Systems Corporation – MTS Test	Document Number: EHS-300-187	Rev.: A
Title: Non-Powered, Material Movement Work Instruction		Page #: 4 of 20	
Work Instruction Owner(s) – list functions: All MTS-EP- Operations Departments and Functional Groups (System Assembly, Checkout, Material Management, Actuator Assembly/Testing, Facilities, etc)		Revision's Training Requirements – select one (per section #9): Awareness _ Formal X	

Powered Industrial Truck: Any mobile power-propelled truck used to carry, push, pull, lift, stack or tier materials. Powered industrial trucks can be ridden or controlled by a walking operator.

Pressure Points: grasping or contact from loads/materials leaning against parts or surfaces that are hard or have sharp edges

Proactive: The identification of an issue prior to it becoming a real problem

Repetitive Motions: actions or activities which are frequently repeated, reaching, lifting, bending, carrying

Recommended Weight Limit (RWL): : Weight of the load that nearly all healthy workers can lift over a sustained period of time (8 hrs.) without increased risk of developing lower back pain = maximum weight to be lifted with two hands under ideal conditions = 51 lbs. = MTS maximum weight lifting limit = 50 lbs.

Static Postures: Maintaining a fixed position for an extended period of time

	<p align="center">QMS Work Instruction</p> <p align="center">MTS Systems Corporation – MTS Test</p>	<p>Document Number: EHS-300-187</p>	<p>Rev.: A</p>
<p>Title: Non-Powered, Material Movement Work Instruction</p>		<p>Page #: 5 of 20</p>	
<p>Work Instruction Owner(s) – list functions: All MTS-EP- Operations Departments and Functional Groups (System Assembly, Checkout, Material Management, Actuator Assembly/Testing, Facilities, etc)</p>		<p>Revision's Training Requirements – select one (per section #9): Awareness _ Formal X</p>	

4 GRAPHICS

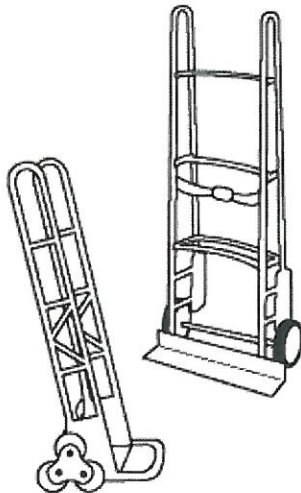

Hand Trucks

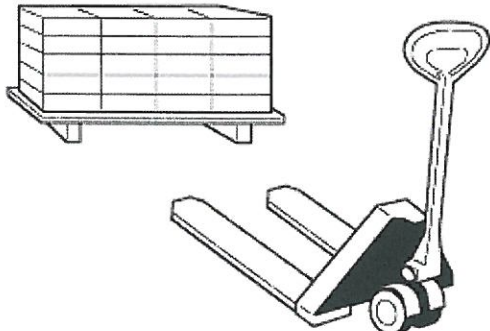

Pallet Jacks

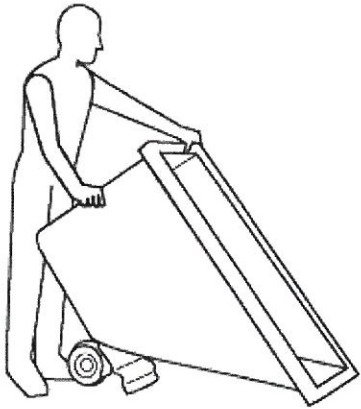

Rolling Bins (Tipping)

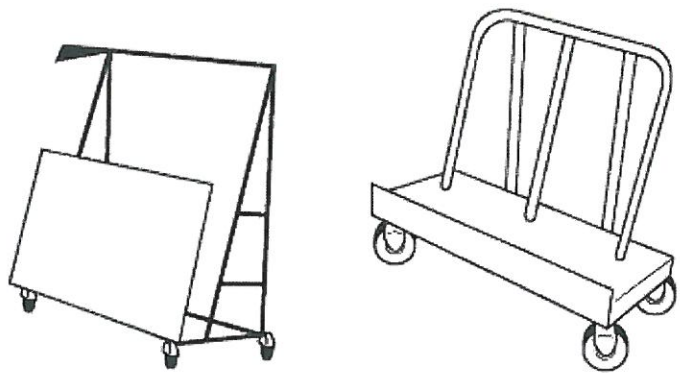

Panel/Lumber Carts

	<p align="center">QMS Work Instruction</p> <p align="center">MTS Systems Corporation – MTS Test</p>	<p>Document Number: EHS-300-187</p>	<p>Rev.: A</p>
<p>Title: Non-Powered, Material Movement Work Instruction</p>		<p>Page #: 6 of 20</p>	
<p>Work Instruction Owner(s) – list functions: All MTS-EP- Operations Departments and Functional Groups (System Assembly, Checkout, Material Management, Actuator Assembly/Testing, Facilities, etc)</p>		<p>Revision's Training Requirements – select one (per section #9): Awareness _ Formal X</p>	



Wheeled Racking



Utility Carts



Flat Carts



Height adjustable Flat Carts

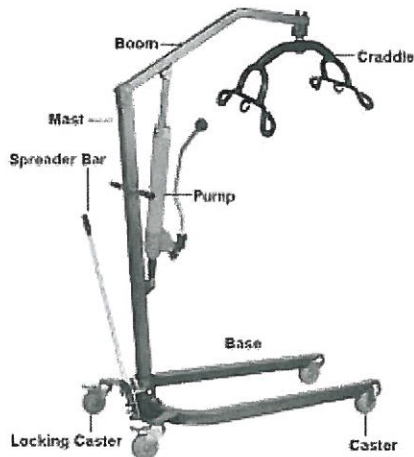

Non – Powered Lifts

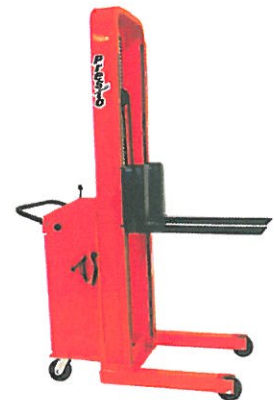

	QMS Work Instruction MTS Systems Corporation – MTS Test	Document Number: EHS-300-187	Rev.: A
Title: Non-Powered, Material Movement Work Instruction		Page #: 7 of 20	
Work Instruction Owner(s) – list functions: All MTS-EP- Operations Departments and Functional Groups (System Assembly, Checkout, Material Management, Actuator Assembly/Testing, Facilities, etc)		Revision's Training Requirements – select one (per section #9): Awareness _ Formal X	

5 RESPONSIBILITIES

- 5.1 Employees** should be able to recognize the methods and equipment needed for eliminating—or at least minimizing—the occurrence of material movement incidences and accidents.
- 5.1.1 Should examine their workplaces to detect any unsafe conditions, practices, or equipment and take appropriate preventative or corrective actions as needed (i.e...Red Tag defective or damaged movement equipment/components and report near-miss events, recognize unsafe conditions, and examine tasks for safer methods or improvements that could be made to area processes and practices)
 - 5.1.4 Limit the storage of materials to designated drop-off, pick-up, in-use or other similar control locations and out of all aisle, walkways, or passageways. Attempt to stock only material needed for more immediate purposes and identify/move out unneeded, unwanted, or excess materials.
 - 5.1.5 Know the load capacity of the various manual carts, pallet jacks, lifts, etc.. , and the nature (best estimate of the component or overall load weight), orientation of the item (load height/length), prior to managing material (consult hard or soft copies of equipment operations manuals – various SAP, BOM, and similar material reference documentation for specific limits and values) .
 - 5.1.6 Know their own personal limitations when it comes to manually handling and managing materials (individuals may have their own physical restrictions as to what they can or should manage = need to notify your Manager/Supervisor regarding these items so they can plan tasks accordingly and provide the appropriate support)
 - 5.1.5 As needed, contact their area Manager/supervisor or appropriate trained, support/material handling personnel if powered movement of items may be needed (Crane, forklift, powered pallet jacks etc..).

	QMS Work Instruction MTS Systems Corporation – MTS Test	Document Number: EHS-300-187	Rev.: A
Title: Non-Powered, Material Movement Work Instruction		Page #: 8 of 20	
Work Instruction Owner(s) – list functions: All MTS-EP- Operations Departments and Functional Groups (System Assembly, Checkout, Material Management, Actuator Assembly/Testing, Facilities, etc)		Revision's Training Requirements – select one (per section #9): Awareness _ Formal X	

5.2 Managers/Supervisors

- 5.2.1 Supervisors are responsible for ensuring the training of employees to the work instruction and taking appropriate measures when compliance with the instructions are not followed
- 5.2.2 Supervisors are expected to report any defective or damaged equipment to the appropriate Facilities or EHS personnel in order to drive repairs or replacement of broken or compromised equipment (Red Tag items) .
- 5.2.3 Ensure that employees have the appropriate material handling equipment and associated information (weight/capacity ratings from hard or soft operations/spec manuals, parts/component dimensions, metrics, etc..), and training, as needed or dictated per their job description and tasks, (ie. powered material training required before any such work is initiated- forklifts, cranes etc.).
- 5.2.5 Support any and all process, handling, or administrative improvements and enhancements as recognized and or needed for increased efficiency, safety, and productivity

5.3 Management

- 5.3.1 Ensure that resources are allocated to support this work instruction and any material handling or process improvements. Establish and support means to enforce compliance with the requirements of this work instruction.

5.4 EHS

- 5.4.1 Ensure clear spaces are maintained with periodic audits and reviews (5S follow ups, scoring and related improvement program initiatives) .
- 5.4.2 Ensure that equipment operation is reviewed, periodically, and maintained.

	QMS Work Instruction MTS Systems Corporation – MTS Test	Document Number: EHS-300-187	Rev.: A
Title: Non-Powered, Material Movement Work Instruction		Page #: 9 of 20	
Work Instruction Owner(s) – list functions: All MTS-EP- Operations Departments and Functional Groups (System Assembly, Checkout, Material Management, Actuator Assembly/Testing, Facilities, etc)		Revision's Training Requirements – select one (per section #9): Awareness _ Formal X	

5.4.2 Resolve any situations or issues that are not addressed or described in this guideline (Risk Assessment creation/evaluation and other analytical tools).

5.5 Facilities Department

5.5.1 Support the marking and signing of designated clear space areas and aisle ways

5.5.2 Assist with any repairs or replacement of defective or damaged equipment.

6 INSTRUCTION

6.1 Common Types of Injuries

6.1.1 Potential injuries that can occur when manually moving materials, include the following

- Strains and sprains from lifting loads improperly or from carrying loads that are either too large or too heavy,
- Fractures and bruises caused by being struck by materials or by being caught in pinch points,
- Cuts and bruises caused by falling materials that have been improperly stored or by incorrectly cutting ties or other securing devices.

6.1.2 Of particular concern are back and overexertion injuries

Back issues:

- Occur when the muscle, ligaments and or tendons in the back are damaged due to overstretching or overuse of the muscles
- Can result in strains, sprains and tears of back supporting muscles

	QMS Work Instruction MTS Systems Corporation – MTS Test	Document Number: EHS-300-187	Rev.: A
Title: Non-Powered, Material Movement Work Instruction		Page #: 10 of 20	
Work Instruction Owner(s) – list functions: All MTS-EP- Operations Departments and Functional Groups (System Assembly, Checkout, Material Management, Actuator Assembly/Testing, Facilities, etc)		Revision's Training Requirements – select one (per section #9): Awareness _ Formal X	

- Herniated disks represent perhaps the most serious type of back injury and result from the outer layer of spinal disks bulging out resulting in serious and often lasting complications

Most back injuries can be attributed to one these six causes:

- Lifting a load that is too heavy
- Incorrect posture when lifting
- Body Mechanics /Work Habits – repetitive activities that impact the same or similar muscle groups or body locations
- Stressful Living
- Loss of Flexibility
- Poor Conditioning

Overexertion issues:

- Are the result of excessive repetitive handling (lifting, pulling, holding turning, carrying, or throwing of materials)
- Can also occur with the use of excessive force related to a single action (often causes nerve, tendon, muscle, and similar support structure damage)

6.2 Items to consider whenever the Movement of Material is Required:

- 6.2.1 What is the known or estimated total weight of the material? What shape is the object? (Oddly shaped/orientated items can cause issues even if relatively light in weight).
- 6.2.2 Has there been effort to stage/move material to afford as short a distance as possible if items need to be moved or manipulated manually or with non-powered equipment?

	QMS Work Instruction MTS Systems Corporation – MTS Test	Document Number: EHS-300-187	Rev.: A
Title: Non-Powered, Material Movement Work Instruction		Page #: 11 of 20	
Work Instruction Owner(s) – list functions: All MTS-EP- Operations Departments and Functional Groups (System Assembly, Checkout, Material Management, Actuator Assembly/Testing, Facilities, etc)		Revision's Training Requirements – select one (per section #9): Awareness _ Formal X	

- 6.2.3 How often will the material need to be moved and if repeated often, could that repetition be reduced with administrative controls, like job rotation, dynamic scheduling, additional mechanical or switch to powered support equipment etc..?
- 6.1.3 What might be needed to secure the material while it is being transported (Ex: straps, blocks, chocks, wedges, etc....)
- 6.2.4 Where will the item be stored? What is the storage elevation (kept on the ground or placed into shelving/storage units etc.)?
- 6.2.5 Can pushing or pulling forces be reduced or eliminated when moving the item?
- 6.2.6 Are the objects or items being moved easy to grasp (good handles, handholds, or grip areas available) and is the item stable to move and or, can be held on to without slipping (assuming it is under the 50 lbs .maximum suggested amount)?
- 6.2.7 What is the general path of the material to be moved? (Consider if the path is wide enough, has an uneven surface, includes any elevation changes, may have obstructions, blind spots, or may be wet/slippy(due to winter snow/ice or rain, condensation, etc....)
- 6.1.6 What will happen if the material does fall while being transported? Make sure to be aware of the potential fall danger zones. (In the case of a falling object, keep all body parts out of these areas at all time
– DO NOT ATTEMPT TO SAVE AN ITEM BY PUTTING YOUR BODY AT RISK – hands, feet etc.)
- 6.2.8 Could mechanical aids be utilized to make the movement safer, and are those aids checked for worn or broken components prior to use?
- 6.2.9 Is adequate assistance available for heavy or awkward lifts where two people or other support may be needed or appropriate?
- 6.2.10 Can working or moving surfaces potentially be adjusted to best handle materials that may need to be managed, worked with and or stored at heights (carts or work

	QMS Work Instruction MTS Systems Corporation – MTS Test	Document Number: EHS-300-187	Rev.: A
Title: Non-Powered, Material Movement Work Instruction		Page #: 12 of 20	
Work Instruction Owner(s) – list functions: All MTS-EP- Operations Departments and Functional Groups (System Assembly, Checkout, Material Management, Actuator Assembly/Testing, Facilities, etc)		Revision's Training Requirements – select one (per section #9): Awareness _ Formal X	

benches that can be height adjusted).?

- 6.2.11 Upon asking and answering all the related material movement questions above, can you determine what equipment is most suitable for the movement of the material? (Ask for guidance or advice from Managers/Supervisors or EHS if unsure).
- 6.2.12 What standard or additional personal protective equipment might be required for the material, item or equipment (gloves, footwear etc.)

6.3 Personal Protective Equipment:

- 6.3.1 Potential Hand and forearm protection, such as leather or similar gloves/sleeves, for loads with sharp or rough edges on components or materials
- 6.3.2 Eye Protection (Safety Glasses)
- 6.3.3 Steel-toed safety shoes or boots with soles that are not overly worn and contain adequate traction in order to prevent slipping
- 6.3.4 Hearing Protection (ear buds, muffs, etc..) may be required when moving items through the machine shops or other floor locations (Main floor when the amber high noise light is engaged)
- 6.2.4 Optional, Metal, fiber, or plastic metatarsal guards to protect the instep area from impact or compression –often recommended for material management staff/personnel as added protection

	QMS Work Instruction MTS Systems Corporation – MTS Test	Document Number: EHS-300-187	Rev.: A
Title: Non-Powered, Material Movement Work Instruction		Page #: 13 of 20	
Work Instruction Owner(s) – list functions: All MTS-EP- Operations Departments and Functional Groups (System Assembly, Checkout, Material Management, Actuator Assembly/Testing, Facilities, etc)		Revision's Training Requirements – select one (per section #9): Awareness _ Formal X	

6.3 General Guidelines:

6.3.1 Anyone lifting items should seek assistance if he/she is not able to comfortably lift an item in a safe manner. MTS guides and job requirements refer to 50 pounds as the maximum that can be manipulated without assistance, anything greater than that should be lifted with assistance, e.g., mechanical-adjustable flat carts, or powered means forklift, hoist, potential for a two person lift etc.

*Note: 50 lbs. is a maximum amount =, assistance, equipment, etc.. may be needed at less than this amount depending on the material, the person moving the item etc., so **employ what is needed, when needed, regardless of the weight)***

6.3.2 Avoid extended reaching, lifting, pulling and manual orientation of product, containers and drums (use as little physical manipulation of items as possible).

6.3.3 Avoid carrying items over any distance. Instead use carts to push objects to their desired location. Pulling carts should be avoided if at all possible.

6.3.4 Whenever needed, use mechanical or powered assistance for items: ie.. frequently handled items or tasks performed throughout the day, moved more than 100 feet or moved over ramps or uneven walking surfaces, items that may not be manipulated safely by hand.

6.3.5 Use of a back belt should be only during the act of lifting. Continual use of back belts worn over an entire work shift or for extended periods of time, can weaken the abdominal and back muscles, exposing employees to additional injury risk (in any case, use of such belts do not guarantee protection from strains or sprains should be used with caution and standard safe lifting practices).

6.4 Proper Lifting Techniques: To minimize the likelihood of a back injury when lifting materials, the following steps should be taken: *Note: MTS Job Descriptions and qualifications state 50 lbs. as the maximum amount for unassisted lifting*

6.4.1 Any lift is always person and object specific

6.4.2 Items may weigh less but will still place strain on the body

	QMS Work Instruction MTS Systems Corporation – MTS Test	Document Number: EHS-300-187	Rev.: A
Title: Non-Powered, Material Movement Work Instruction		Page #: 14 of 20	
Work Instruction Owner(s) – list functions: All MTS-EP- Operations Departments and Functional Groups (System Assembly, Checkout, Material Management, Actuator Assembly/Testing, Facilities, etc)		Revision's Training Requirements – select one (per section #9): Awareness _ Formal X	

- 6.4.3 ALL EMPLOYEES are encouraged to seek assistance, as needed, for any lifting of materials, regardless of the weight (when in doubt seek assistance from colleagues, supervisors or EHS and if possible, utilize other mechanical/powered means if trained to do so).

Safe Lifting Guide:

1. Plan ahead before lifting.

Know what you're doing and where you're going to help prevent you from making awkward movements or turning awkwardly while holding heavy object. Clear a path, and if lifting something with another person, make sure both of you agree on the plan.

2. Stand Close to the Load:

Stand close to the load with your feet spread apart about shoulder width. Place one foot slightly in front of the other for balance.



3. Bend at the Knees:

Squat down bending at the knees (not your waist). Tuck your chin while keeping your back as vertical as possible.



4. Control the Load:

Get a firm grasp of the object before beginning the lift.



	<p align="center">QMS Work Instruction</p> <p align="center">MTS Systems Corporation – MTS Test</p>	Document Number: EHS-300-187	Rev.: A
Title: Non-Powered, Material Movement Work Instruction		Page #: 15 of 20	
Work Instruction Owner(s) – list functions: All MTS-EP- Operations Departments and Functional Groups (System Assembly, Checkout, Material Management, Actuator Assembly/Testing, Facilities, etc)		Revision's Training Requirements – select one (per section #9): Awareness _ Formal X	

5. Lift with Your Legs:

Begin slowly lifting with your LEGS by straightening them. Never twist your body during this step



6. Keep Load Close to Body:

Once the lift is complete, keep the object as close to the body as possible. As the load's center of gravity moves away from the body, there is a dramatic increase in stress to the lumbar region of the back.

- If you must turn while carrying the load, *turn using your feet-not your torso*. Keep your eyes up. Looking slightly upwards will help you maintain a better position of the spine.



6.4.4 Lifting Dos and Don'ts

Dos:

Do place your feet and knees at least shoulder width apart or front to back in a wide-step position. This will help you bend at the hips, keeping your back relatively straight and stress free.

	QMS Work Instruction MTS Systems Corporation – MTS Test	Document Number: EHS-300-187	Rev.: A
Title: Non-Powered, Material Movement Work Instruction		Page #: 16 of 20	
Work Instruction Owner(s) – list functions: All MTS-EP- Operations Departments and Functional Groups (System Assembly, Checkout, Material Management, Actuator Assembly/Testing, Facilities, etc)		Revision's Training Requirements – select one (per section #9): Awareness _ Formal X	

- **Do** lean over or squat with the chest and buttocks sticking out. If you do this correctly, your back will be flat and your neck will balance in a relaxed neutral position.
- **Do** take weight off one or both arms if possible. When you squat down or push back up, use your hand or elbow as support on your thigh or any available structure. This takes some of the compression and strain off of the lower back.
- **Do** balance your load on either side if possible, or switch sides so that both sides are equally stressed.
- **Do** walk around and use backward-bending and/or stomach-lying positions before or after bending or heavy lifting, especially if you've been sitting for a while.

Don'ts:

- **Don't** lift things when your feet are too close together. If your feet are closer than shoulder width you'll have poor leverage, you'll be unstable, and you'll have a tendency to round your back.
- **Don't** lift with your knees and hips straight and your lower back rounded. This is the most common and stressful bad lifting move. Twisting the trunk during this bad move compounds the problem.
- **Don't** tense and arch the neck when lifting. This crams your neck joints together and causes pain especially if maintained for a long period of time.
- **Don't** twist or turn when carrying a heavy load.
- **Don't** lift and/or carry an unbalanced load.
- **Don't** lift and bend too much in a short period of time.
- **Don't** lift objects that are too heavy for you.
- **Don't** mistakenly believe that a lifting belt will increase your maximum lifting potential.

	<p align="center">QMS Work Instruction</p> <p align="center">MTS Systems Corporation – MTS Test</p>	<p>Document Number: EHS-300-187</p>	<p>Rev.: A</p>
<p>Title: Non-Powered, Material Movement Work Instruction</p>		<p>Page #: 17 of 20</p>	
<p>Work Instruction Owner(s) – list functions: All MTS-EP- Operations Departments and Functional Groups (System Assembly, Checkout, Material Management, Actuator Assembly/Testing, Facilities, etc)</p>		<p>Revision's Training Requirements – select one (per section #9): Awareness _ Formal X</p>	

- **Don't** lift heavy objects directly following a sustained period of sitting, especially if you have been slouching.

- **Don't** lift things overhead with your neck and back arched, if possible.

- When evaluation lifting habits keep in mind the following key items
 - Frequency of lifting
 - Angle of the body
 - Body size, age and general physical fitness
- Material handling tasks should be designed to minimize the weight, range of motion and the frequency of activity – with mechanical or powered assistance as an option to be always be considered or utilized

6.5 Team Lifting

Team lifting should be used only as needed or necessary, as the likelihood of injury due to slipping, tripping, falling, and dropping are increased. Whenever team lifting is employed, the participants should carefully discuss the plan for the lift, including any verbal instructions that will be used to initiate actions and to warn of hazards.

6.4 Carts

6.4.1 For control and stability carts should be no greater than four feet in length, three feet in width and 53 inches in height.

6.4.2 Cart handles should be at a height between 36 and 44 inches.

6.8.3 Cart handles should be circular in shape and a maximum diameter of 1.5 inches and a minimum diameter of 1 inch.

6.9 Shelving

	QMS Work Instruction MTS Systems Corporation – MTS Test	Document Number: EHS-300-187	Rev.: A
Title: Non-Powered, Material Movement Work Instruction		Page #: 18 of 20	
Work Instruction Owner(s) – list functions: All MTS-EP- Operations Departments and Functional Groups (System Assembly, Checkout, Material Management, Actuator Assembly/Testing, Facilities, etc)		Revision's Training Requirements – select one (per section #9): Awareness _ Formal X	

- 6.9.1 Items that are frequently accessed and weigh more than 15 pounds should be stored on shelving between 33 and 48 inches above the floor.
- 6.9.2 Items stored on shelves higher than 48 inches should be located toward the front of the shelf.
- 6.9.3 Use a step stool to access items stored above 64 inches.
- 6.9.4 Shelving should be designed such that there is enough vertical clearance to safely load and unload the items onto the shelf.
- 6.9.5 Access to shelving should always remain free of any obstructions.

6.10 Containers

- 6.10.1 Container handles should promote carrying the load in front of the body with weight evenly distributed.
- 6.10.2 Optimal width of a container is 14 inches; the maximum recommended width is 20 inches.
- 6.10.3 Optimal length of a container is 20 inches; the maximum recommended length is 30 inches.
- 6.10.4 Optimal depth / height of a container is 6 inches; the maximum recommended depth / height is 18 inches.
 - * ensure that a good estimate or determination of the container weight is available, prior to moving and the capacity of the container matches that total weight to avoid it becoming compromised, potentially, while moving – check manufacturer recommendations and guidelines, internal SAP systems, use floor and or local scales etc..*

	QMS Work Instruction MTS Systems Corporation – MTS Test	Document Number:	Rev.:
		EHS-300-187	A
Title: Non-Powered, Material Movement Work Instruction		Page #:	19 of 20
Work Instruction Owner(s) – list functions: All MTS-EP- Operations Departments and Functional Groups (System Assembly, Checkout, Material Management, Actuator Assembly/Testing, Facilities, etc)		Revision's Training Requirements – select one (per section #9): Awareness _ Formal X	

7 ASSOCIATED QUALITY RECORDS – AS STATED IN THE QUALITY RECORDS LIST

Required Record
LMS Training records

8 REFERENCE FORMS / TEMPLATES / DOCUMENTS (IF NEEDED)

Form / Template / Document Title	Location
Sign in Training Sheet (HR 400-102)	HR Web



9 CURRENT REVISION'S TRAINING REQUIREMENTS

Select One (mark X)	Training Type	Training Definition
	Awareness	Awareness training is conducted by communication, which is sent/delivered by the approver/author/owner of the document to the affected employees/groups.
X	Formal	Formal training requires the approver/author/owner to collect/store evidence that the affected employees/groups were trained.

	QMS Work Instruction MTS Systems Corporation – MTS Test	Document Number: EHS-300-187	Rev.: A
	Title: Non-Powered, Material Movement Work Instruction	Page #: 20 of 20	
Work Instruction Owner(s) – list functions: All MTS-EP- Operations Departments and Functional Groups (System Assembly, Checkout, Material Management, Actuator Assembly/Testing, Facilities, etc)		Revision's Training Requirements – select one (per section #9): Awareness _ Formal X	

10 REVISION HISTORY & APPROVAL

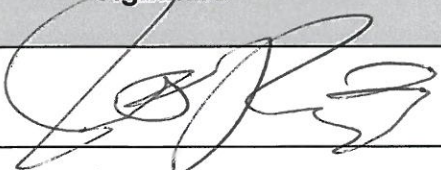
REVISION HISTORY			
Rev	Description of Change	Author	Effective Date
A	Original	James Kinney	01/27/2016

APPROVAL OF CURRENT REVISION		
Name / Function	Signature	Date
James Kinney, EHS Manager- Document Originator		1-14-16
Tom Milas Vice President- Global Operations - EHS Management		1/22/16